

design **FLAMINIA DESIGN TEAM**

2010

F6MW suitable for Miniwash (MWL40 - MWL48 - MWL60 - MWL75)

Shelf from 80 to 250 x 46 x h 10 cm suitable for countertop basins
Miniwash (fixing brackets included)

- Complements:
- Make-Up mirrors and lamps
 - Compono System furnishings and mirrors
 - Simple mirrors
 - Hot/Cold mirror (SPHC)
 - Left/Right mirror (SPLR)
 - Line mirrors (BASC20 - BASC30)



Tap holes are not made on this article by Flaminia

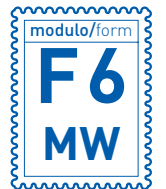
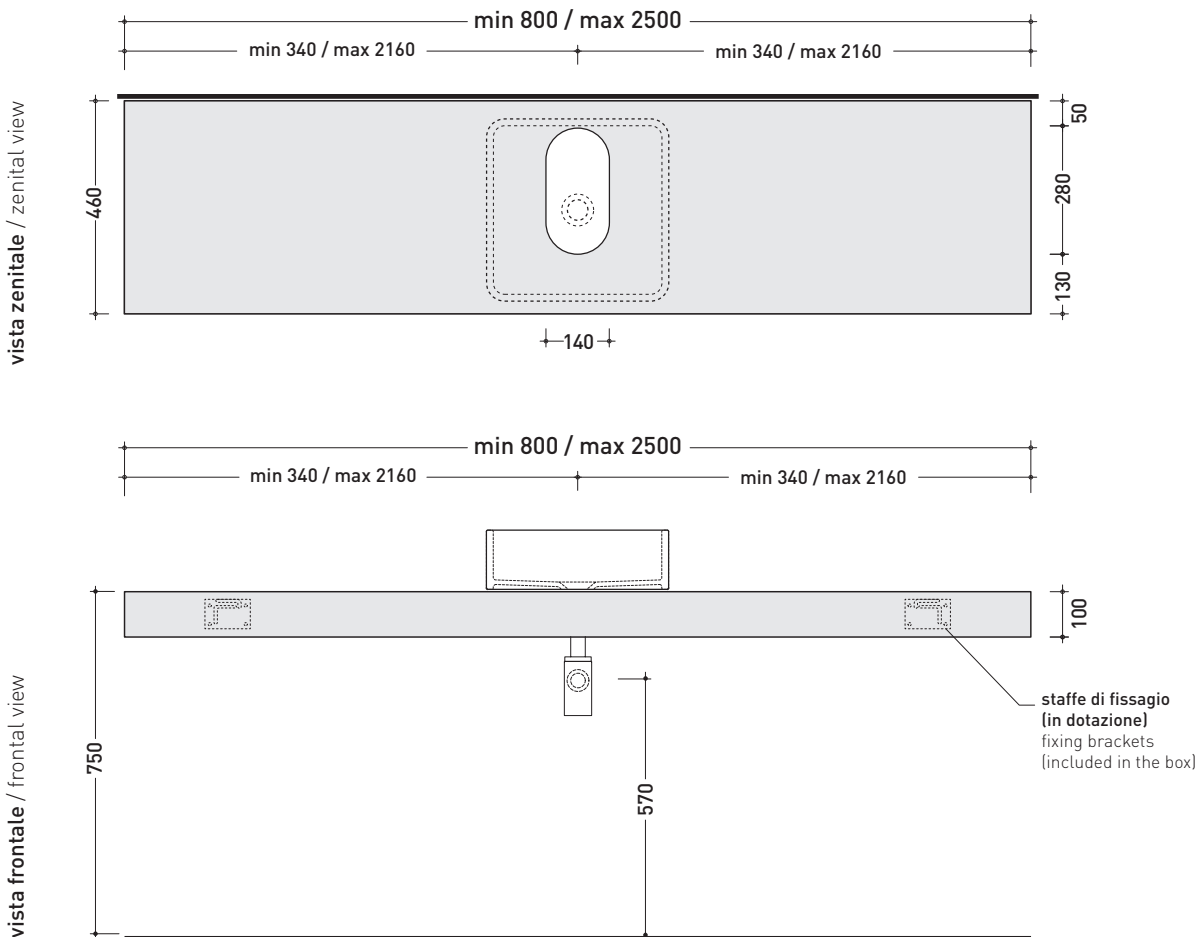

REFERENCE TO
THE COMPULSORY
ORDER FORM

size in mm

may 2015

PIETRALUCE: glossy finish



PIETRALUCE: matt finish



MATRIX: finishes



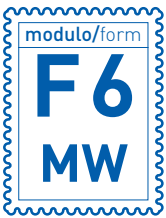

MODULO PER LA REALIZZAZIONE DELLE MENSOLE **FORTY6** A MISURA PER ART. **MWL40 / MWL48 / MWL60 / MWL75**

FORTY6 CUSTOMIZED SHELVES FOR ART. **MWL40 / MWL48 / MWL60 / MWL75** FORM



E' obbligatorio fotocopiare questa pagina, compilarla con cura e allegarla all'ordine.
It is compulsory to photocopy this page, carefully fill in and attach to the order.

➤➤ 1 DETTAGLI ORDINE / ORDER DETAILS

cliente - client

ordine - order n:

data - date:

ref.:

annotazioni - notes

➤➤ 2 SCELTA ARTICOLO / ITEM CHOICE

E' importante consultare prima la scheda tecnica relativa
It's important to consult before the technical detail

art. **F6MW**

mensola / shelf da / from 80 a / to 250 cm

➤➤ 3 SCELTA MATERIALE / MATERIAL SELECTION

PIETRALUCE

bianco - white

grigio - grey

beige - beige

rosa - pink

blu ultram. - marine blue

grafite - graphite

nero - black

sabbia - sand

rosso cuoio - red

azzurro - light blue

latte - milky white

gr. lava - lava grey

FINITURE MATRIX / MATRIX FINISHES

T. wengè - T. wengè

T. sabbia - T. sand

T. caffè - T. coffee

➤➤ 4 SCELTA MISURE / MEASURES

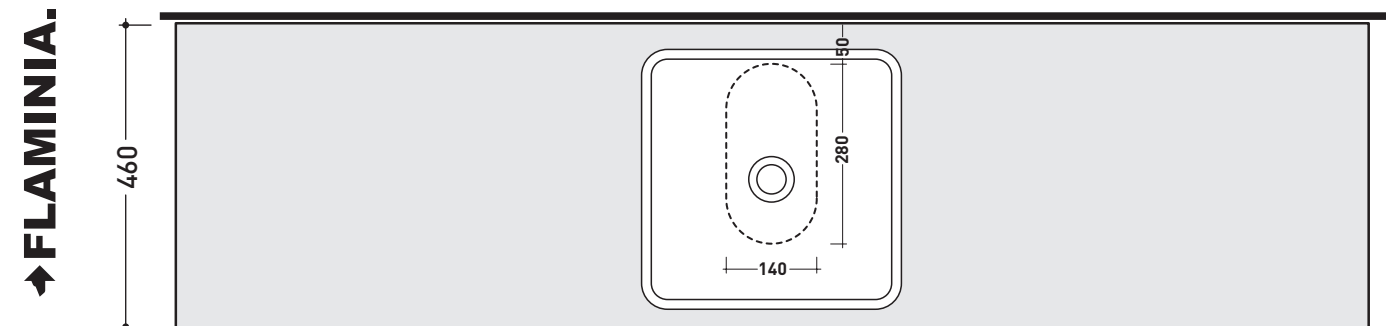

lavabo / basin
MWL40 - MWL48 - MWL60 - MWL75



- **A** = misura interasse lavabo da sinistra / left distance of basin.
- **B** = misura interasse lavabo da destra / right distance of basin.
- **C** = misura totale della mensola / total length of the shelf.
- verificare sempre che / verify that: **A + B = C**.

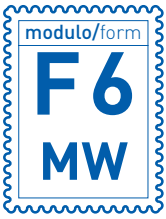

MODULO PER LA REALIZZAZIONE DELLE MENSOLE **FORTY6** A MISURA PER ART. **MWL40 / MWL48 / MWL60 / MWL75**

FORTY6 CUSTOMIZED SHELVES FOR ART. MWL40 / MWL48 / MWL60 / MWL75 FORM



E' obbligatorio fotocopiare questa pagina, compilarla con cura e allegarla all'ordine.
It is compulsory to photocopy this page, carefully fill in and attach to the order.

➔➔ 1 DETTAGLI ORDINE / ORDER DETAILS

cliente - client _____

ordine - order n: _____ data - date: _____ ref.: _____

annotazioni - notes _____

➔➔ 2 SCELTA ARTICOLO / ITEM CHOICE

E' importante consultare prima la scheda tecnica relativa
It's important to consult before the technical detail

art. **F6MW**
mensola / shelf da / from 165 a / to 250 cm

➔➔ 3 SCELTA MATERIALE / MATERIAL SELECTION

PIETRALUCE

- | | |
|--|---|
| <input type="checkbox"/> bianco - white | <input type="checkbox"/> nero - black |
| <input type="checkbox"/> grigio - grey | <input type="checkbox"/> sabbia - sand |
| <input type="checkbox"/> beige - beige | <input type="checkbox"/> rosso cuoio - red |
| <input type="checkbox"/> rosa - pink | <input type="checkbox"/> azzurro - light blue |
| <input type="checkbox"/> blu ultram. - marine blue | <input type="checkbox"/> latte - milky white |
| <input type="checkbox"/> grafite - graphite | <input type="checkbox"/> gr. lava - lava grey |

FINITURE MATRIX / MATRIX FINISHES

- | | |
|--|---|
| <input type="checkbox"/> T. wengè - T. wengè | <input type="checkbox"/> T. caffè - T. coffee |
| <input type="checkbox"/> T. sabbia - T. sand | |

➔➔ 4 SCELTA MISURE / MEASURES

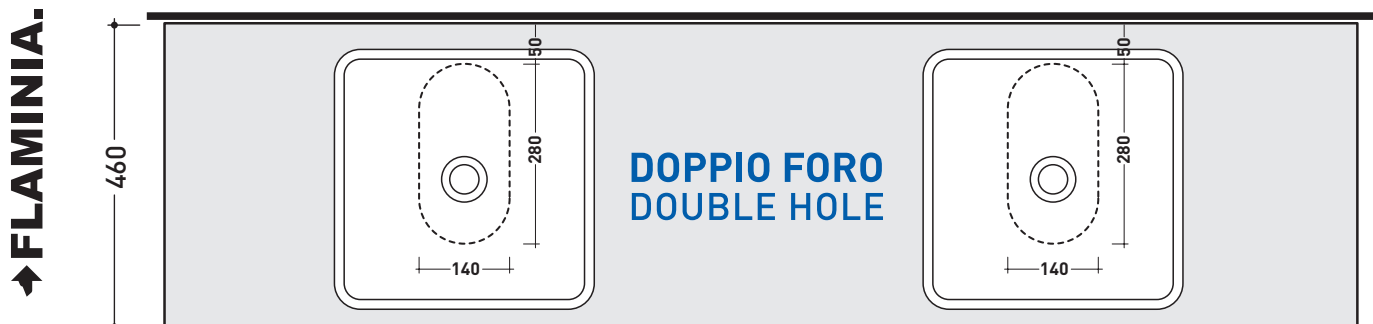
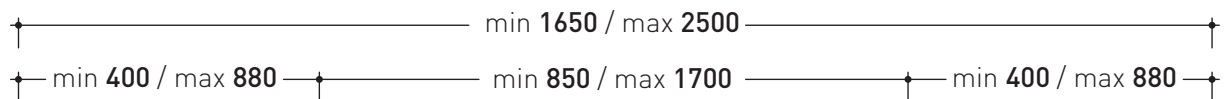

lavabo / basin
MWL40 - MWL48 - MWL60 - MWL75

lavabo / basin
MWL40 - MWL48 - MWL60 - MWL75



- A = misura interasse lavabo da sinistra / left distance of basin.
- B = misura interasse lavabi / distance between basins.
- C = misura interasse lavabo da destra / right distance of basin.

- D = misura totale della mensola / total length of the shelf.
- verificare sempre che / verify that: **A + B + C = D.**